



Quality Products. Service Excellence.

Tube Output (10 - 280 Watts) 1608-1650 Series

Push-Pull - HI-FI



Features

- Please see our NEW & improved versions (**easy wire secondary series**).
- Designed for push-pull tube output circuits.
- Enclosed (shielded), 4 slot, above chassis Type "X" mounting.
- Frequency response 30 Hz. to 30 KHz. at full rated power (+/- 1 db max. - ref. 1 KHz) minimum.
- Insulated flexible leads 8" min.
- Manufactured with plastic coil forms for coil support and insulation.
- Typical applications - Push-Pull: triode, Ultra-Linear pentode, pentode and tetrode connected audio output.
- Due to the unique interleaving of the windings BOTH secondary windings must be engaged to meet specifications (see hook-up diagrams below).
- For the "ultimate" in Push-Pull output see our line of **epoxy potted output transformers**.

1645 Only

- **Secondary Connections** (Due to the unique interleaving of the windings **BOTH** secondary windings must be engaged to meet specifications)
- To hook up 4/8/16 ohm secondary loads - see schematic (do not use the white wire).
- To hook up secondary to 70V loads, jumper Blk/Yel wire to Grn wire. Connect load to Blk and White wires.

Gallery

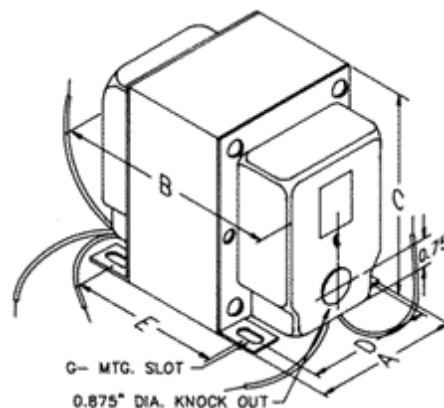

Part No.	Audio Watts (RMS)	Primary Impedance (Ohms)	Maximum DC Per Side	Secondary Impedance (Ohms)	Dimensions							Weight (lbs.)	
					A	B	C	D	E +/- 1/16"	G Slot			
1608	10	8,000 ct	100 ma.	4-8-16	2.50	2.75	3.06	2.00	1.69	0.20	x	0.38	2.5
1609	10	10,000 ct	100 ma.	4-8-16	2.50	2.75	3.06	2.00	1.69	0.20	x	0.38	2.5
1615	15	5,000 ct	100 ma.	4-8-16	2.50	3.25	3.06	2.00	2.19	0.20	x	0.38	3.25
1620	20	6,600 ct	158 ma.	4-8-16	2.50	3.50	3.06	2.00	2.44	0.20	x	0.38	3.5
1650F	25	7,600 ct	128 ma.	4-8-16	2.50	3.50	3.06	2.00	2.44	0.20	x	0.38	4
1645	30	5,000 ct	128 ma.	4-8-16-70V	2.50	3.75	3.06	2.00	2.69	0.20	x	0.38	4.5
1650H	40	6,600 ct	200 ma.	4-8-16	3.13	4.00	3.81	2.50	2.69	0.20	x	0.38	6.5
1650K	50	3,400 ct	318 ma.	4-8-16	3.13	4.00	3.81	2.50	2.69	0.20	x	0.38	7
1650M	60	1,400CT/800CT	318 ma.	4-8-16	3.13	4.19	3.80	2.50	2.94	0.20	x	0.38	7.5
1650N	60	4,300 ct	318 ma.	4-8-16	3.13	4.25	3.81	2.50	2.94	0.20	x	0.38	8
1650P	60	6,600 ct	200 ma.	4-8-16	3.13	4.25	3.81	2.50	2.94	0.20	x	0.38	8
1650R	100	5,000 ct	318 ma.	4-8-16	3.75	4.25	4.56	3.00	3.06	0.20	x	0.38	12
1650T	120	1,900 ct	403 ma.	4-8-16	3.75	4.50	4.56	3.00	3.31	0.20	x	0.38	14
1650W	280	1,900 ct	806 ma.	4-8-16	4.38	7.50	5.25	3.50	5.88	0.20	x	0.38	28

Suggested Tube Types

Part No.	Audio Watts (R.M.S.)	Primary Impedance (Ohms)	Operation	Suggested Tube Types
1608	10	8,000 ct	Push-Pull (2 Tubes)	6AQ5, 6V6, 6BQ5, EL84, SV83
1609	10	10,000 ct	Push-Pull (2 Tubes)	6AQ5, 6V6, 6BQ5, EL84, SV83
1615	15	5,000 ct	Push-Pull (2 Tubes)	2A3, 6A3, 6AQ5, 6B4G, 6L6, 6V6
1620	20	6,600 ct	Push-Pull (2 Tubes)	6AQ5, 6L6, 6V6
1650F	25	7,600 ct	Push-Pull (2 Tubes)	6L6GC, 6V6, 807, 5881, EL34
1645	30	5,000 ct	Push-Pull (2 Tubes)	6L6GC, 6V6, 807, 5881, EL34
1650H	40	6,600 ct	Push-Pull (2 Tubes)	6L6GC, 807, 5881, EL34
1650K	50	3,400 ct	Push-Pull Par. (4 Tubes)	6L6GC, 807, 5881, EL34, 6146B, 6550B
1650N	60	4,300 ct	Push-Pull Par. (2 or 4 Tubes)	6L6GC, 807, 5881, EL34, 6146B, 6550B, KT88
1650P	60	6,600 ct	Push-Pull (2 Tubes)	6L6GC, 807, 5881, EL34, 6146B, 6550B, KT88
1650R	100	5,000 ct	Push-Pull Par. (2 or 4 Tubes)	807, 5881, EL34, 6146B, 6550B, KT88
1650T	120	1,900 ct	Push-Pull Par. (4 or 6 Tubes)	6L6GC, 5881, EL34, 6550B, KT88
1650W	280	1,900 ct	Push-Pull Par. (6 or 8 Tubes)	6L6GC, 5881, EL34, 6550B, KT88

Notes: The above examples of possible combinations are to help you narrow down the choices of transformers for your favorite tube types. How you operate the tubes (push-pull, push-pull parallel, ultra-linear, class, B+, bias, operating points, etc.) will change optimum plate to plate load impedance. Only a few of the most popular tubes are shown. As more tubes become available we will add them to the list. A tube manual or tube manufacturer's technical data sheets should be consulted first, before making a decision on a proper output transformer.

Tags: **classic transformer, push-pull, tube output, triode, pentode, tetrode, output circuit**

Data subject to change without notice

© 2024. Hammond Manufacturing Ltd. All rights reserved.