

MAIN FEATURES

COMPACT, UP TO 12 POSITIONS

- > 25'000 switching cycles with up to 6 Ncm switching torque
- > Gold plated contacts: 3 micron
- > Robust metal bushing and shaft
- > Operating temperature: Up to -40° to +85°C
- > Front panel sealing: Up to IP68
- > Various options and customizations



TYPE 01

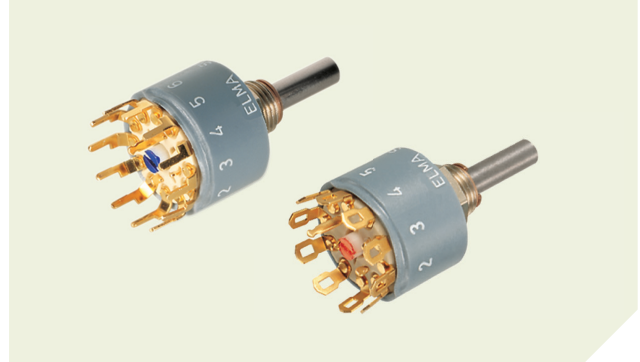

PRODUCT VARIETY

- Soldering eyelets or pins for PCB
- From 1 x 12 to 4 x 3 poles/positions per wafer
- Single or dual wafer
- Indexing angle: 30°, 36° or 60°
- Shorting or non-shorting
- Switching torque: 2, 4 or 6 Ncm
- Front panel sealing: IP60 or IP68
- Configurable End-Stops
- Shaft diameter: 3, 4 or 6 mm
- Shaft length

NUT (SUPPLIED)

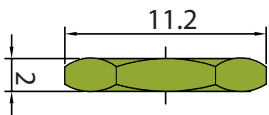

Wrench size 10 mm
M8 x 0.75

Spare Part

Order number (10 pcs. bag)
- Brass nickel plated: 4024-81

POSSIBLE CUSTOMIZATIONS

- Shaft dimension and shape
- Bushing dimensions
- Switching torque
- Hollow shaft, inner shaft
- Pull/push-to-turn
- Others















TYPICAL APPLICATIONS

- Industrial controls
- Avionics, instrumentation, test systems
- Medical and audio equipment
- Construction









1 PREFERENCE TYPES SELECTION CHART

¹ For other types/options, see type key.



INDEXING ANGLE 30°, SHORTING

CONTACT ARRANGEMENT	NUMBER OF WAFERS	FUNCTION (POLES X POSITIONS)	STANDARD TYPE KEY	
			WITH SOLDER EYELETS	WITH PINS FOR PCB
		1 x 12, endless rotating	01-1123	01-1123-20
		2 x 12, endless rotating	01-2123	-
		1 x 12	01-1183	01-1183-20
		2 x 12	01-2183	-
		1 x 11	01-1113	01-1113-20
		2 x 11	01-2113	-
		2 x 6	01-1263	01-1263-20
		4 x 6	01-2263	-
		4 x 3	01-1433	01-1433-20
		8 x 3	01-2433	-









INDEXING ANGLE 30°, NON-SHORTING

CONTACT ARRANGEMENT	NUMBER OF WAFERS	FUNCTION (POLES X POSITIONS)	STANDARD TYPE KEY	
			WITH SOLDER EYELETS	WITH PINS FOR PCB
		1 x 12, endless rotating	01-1124	01-1124-20
		1 x 12	01-1184	01-1184-20
		1 x 11	01-1114	01-1114-20
		2 x 6	01-1264	01-1264-20
		4 x 3	01-1434	01-1434-20

INDEXING ANGLE 36°, SHORTING

CONTACT ARRANGEMENT	NUMBER OF WAFERS	FUNCTION (POLES X POSITIONS)	STANDARD TYPE KEY	
			WITH SOLDER EYELETS	WITH PINS FOR PCB
		1 x 10, endless rotating	01-1103	01-1103-20
		1 x 10	01-1193	01-1193-20

INDEXING ANGLE 60°, NON-SHORTING

CONTACT ARRANGEMENT	NUMBER OF WAFERS	FUNCTION (POLES X POSITIONS)	STANDARD TYPE KEY	
			WITH SOLDER EYELETS	WITH PINS FOR PCB
		1 x 6, endless rotating	01-1104	01-1104-20
		1 x 6	01-1164	01-1164-20
		2 x 3	01-1234	01-1234-20
		4 x 2	01-1424	01-1424-20

STOP PINS

PACKAGING UNIT	ORDER NUMBER
10 pcs.	4007-36
50 pcs.	4007-35

On switches with fixed end-stop, additional stops can be set, by means of a plastic pin, on any position between 2 and the maximum (stop pins to be ordered separately).

SPECIFICATIONS

MECHANICAL DATA

Resolution:	12 positions max. (30° indexing); shorting or non-shorting 10 positions max. (36° indexing); shorting 6 positions max. (60° indexing); non-shorting
Switching torque (new condition):	2, 4 or 6 Ncm (+/- 25%), additional wafers may increase switching torque
Rotational life:	25'000 cycles min.
Fastening torque of nut:	300 Ncm max.

ELECTRICAL DATA

Functions:	From 1 x 12 to 4 x 3 poles/positions per wafer (max. 2 wafers)
Switching mode:	Shorting (for 30° and 36° indexing) Non-shorting (for 30° and 60° indexing)
Load current:	2 A max. (resistive load)
Switching voltage:	42 VDC max.
Contact resistance (new condition):	10 mΩ max.
Insulation resistance:	10 ¹¹ Ω min. (contact to contact / housing)
Switching capacity:	1 pF max. (contact to contact)
Dielectric withstanding voltage:	500 VDC during 60 seconds (pin to pin, pin to housing)

MATERIAL DATA

Shaft:	Stainless steel
Bushing:	Nickel silver
Housing:	Fiber enforced plastic
Nut:	Brass with glossy nickel plating
Contact plating:	Gold; 3 μm
Insulation material:	Wafer: HF ceramic, rotor: Polybutylene
Soldering leads:	Alloy copper, gold plated

ENVIRONMENTAL DATA

Operating/storage temperature range:	-40 to +85°C max.
IP sealing:	IP60, optional IP68 (2 bar, 1 h) shaft / front panel sealing
Vibration:	10 G _{rms} max. @ 10 to 2000 Hz
Flammability:	UL94-HB

PACKAGING QUANTITY

Tray:	10 pcs.
-------	---------

SOLDERING CONDITIONS

Hand soldering:	340°C max. during 2 sec max.
Wave soldering:	280°C max. peak temperature during 5 sec max.

SWITCHING MODES

For information about switching modes please see **technical explanations** at the end of the catalog

DRAWINGS

Tolerances unless otherwise specified DIN ISO 2768-1 (m)

WITH SOLDER EYELETS

1 WAFER

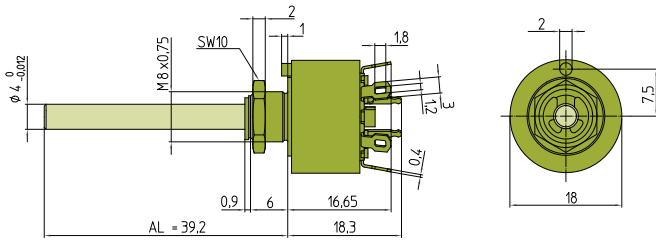

2 WAFER

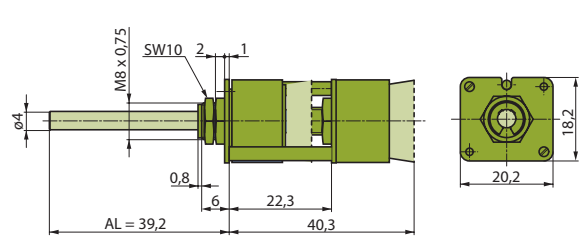

SW = key spanner

WITH PINS FOR PCB

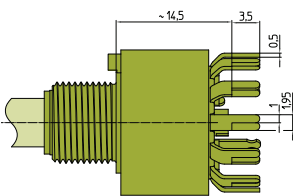

DRILLING DIAGRAM FOR 30° INDEXING ANGLE

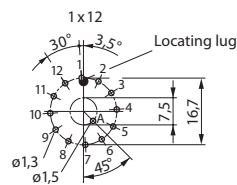

DRILLING DIAGRAM FOR 36° INDEXING ANGLE

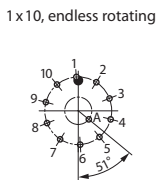
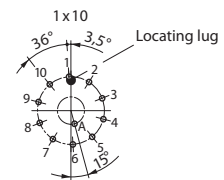

DRILLING DIAGRAM FOR 60° INDEXING ANGLE

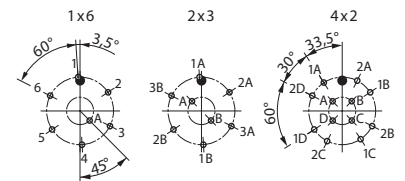

FRONT PANEL CUT OUT

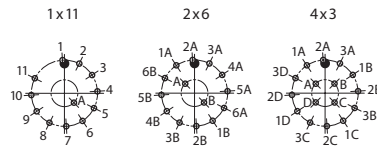
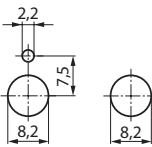

SPECIAL SHAFT DIAMETER

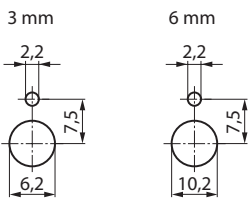

TYPE O1 switches are also available with the following shaft diameters:

ϕ	AL (STANDARD)	BUSHING	NUT SIZE
3 mm	59 mm	M6 x 0.75 x 6.0 mm	10 mm
6 mm	28 mm	M10 x 0.75 x 8.0 mm	14 mm

HOLLOW SHAFT SYSTEM (CUSTOMIZED SOLUTION)

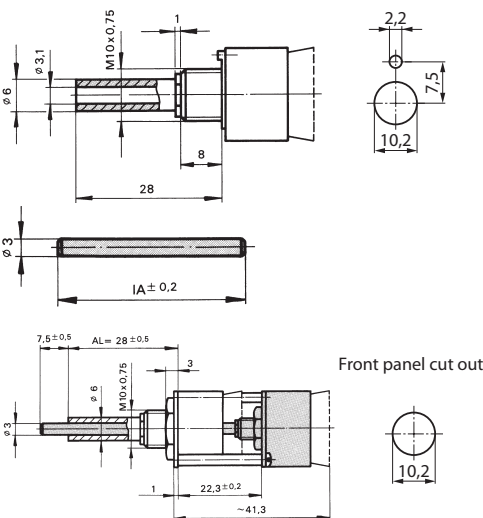

HOLLOW SHAFT

Hollow shaft to allow concentric operation of either two switches or, for example, a switch and a potentiometer. The inner shaft ($\phi 3$ mm) must be ordered separately.

INNER SHAFT

Must be ordered separately for switches with hollow shaft.

SWITCHES WITH CONCENTRIC SHAFTS

It is possible for two switches to be operated individually by concentric shafts on the same mounting. When ordering, the type number of each switch must be given and specified.

TYPE KEY

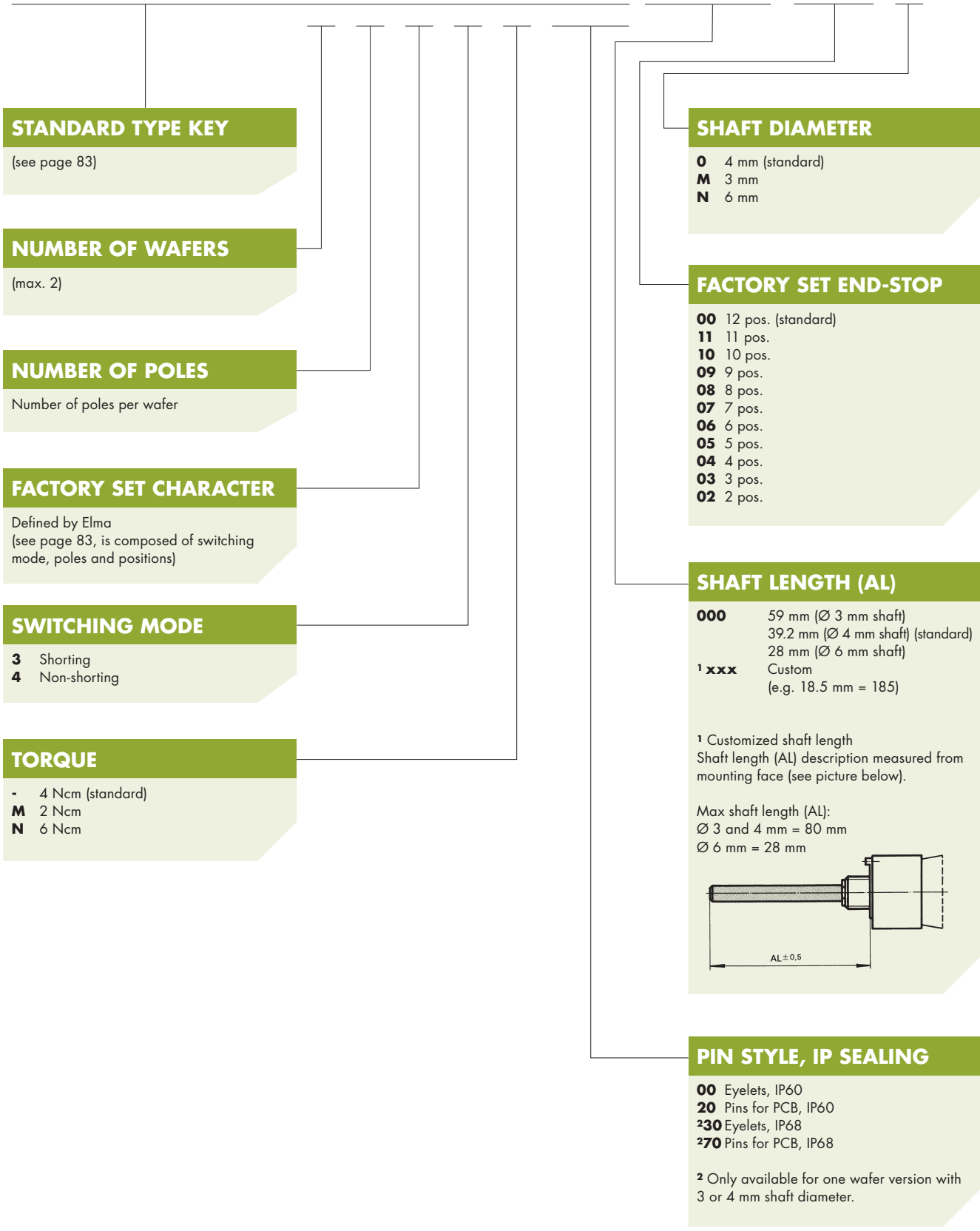

STANDARD TYPE KEY
(see page 83)

NUMBER OF WAFERS
(max. 2)

NUMBER OF POLES
Number of poles per wafer

FACTORY SET CHARACTER
Defined by Elma
(see page 83, is composed of switching mode, poles and positions)

SWITCHING MODE
3 Shorting
4 Non-shorting

TORQUE
- 4 Ncm (standard)
M 2 Ncm
N 6 Ncm

SHAFT DIAMETER
O 4 mm (standard)
M 3 mm
N 6 mm

FACTORY SET END-STOP
00 12 pos. (standard)
11 11 pos.
10 10 pos.
09 9 pos.
08 8 pos.
07 7 pos.
06 6 pos.
05 5 pos.
04 4 pos.
03 3 pos.
02 2 pos.

SHAFT LENGTH (AL)
000 59 mm (Ø 3 mm shaft)
39.2 mm (Ø 4 mm shaft) (standard)
28 mm (Ø 6 mm shaft)
¹ xxx Custom
(e.g. 18.5 mm = 185)

¹ Customized shaft length
Shaft length (AL) description measured from mounting face (see picture below).

Max shaft length (AL):
Ø 3 and 4 mm = 80 mm
Ø 6 mm = 28 mm

PIN STYLE, IP SEALING
00 Eyelets, IP60
20 Pins for PCB, IP60
²30 Eyelets, IP68
²70 Pins for PCB, IP68

² Only available for one wafer version with 3 or 4 mm shaft diameter.

TECHNICAL EXPLANATIONS

GENERAL SWITCH KNOWLEDGE

POSITION

A position is the mechanical detent of a switch actuator.

DETENT

A detent is a mechanical positioning device for stopping actuator travel at each successive electrical circuit; for example, a spring-operated ball and groove.

POLE

A pole is a single common electrical input having one or more outputs.

WAFER, DECK OR LAYER

A wafer/deck or layer is a section what the contacts are mounted on.

INDEXING ANGLE

An indexing angle is the number of degrees between each position.
For example: 12 positions for a total of 360 degrees result a 30 degrees indexing angle.

NON-SHORTING CONTACTS "BREAK BEFORE MAKE"

A non-shorting contact is also known as "break before make" and describes the action of one circuit of a pole before interrupting another of the same pole. The switch will be momentarily interrupted before it changes from position 1 to position 2 during actuation (see picture).

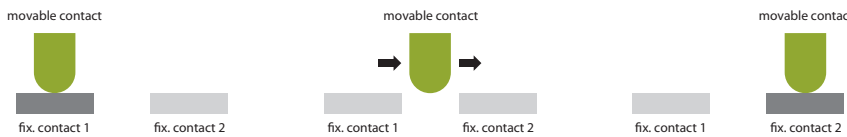

SHORTING CONTACTS "MAKE BEFORE BREAK"

A shorting contact is also known as "make before break" and describes the action of one circuit of a pole before interrupting another of the same pole. The switch will momentarily "short" position 1 and 2 during actuation (see picture).

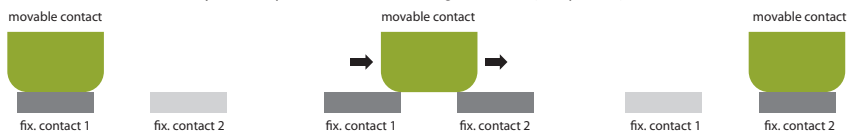

CYCLE

A cycle is the complete sequence of indexing through all successive switch positions and returning to the original position. The rotational life from coded or selector switches are usually specified with cycles.

REVOLUTION

A revolution is the complete sequence of indexing through all successive switch positions in the same direction. The rotational life from encoded switches are usually specified with revolutions.

BENEFITS OF GOLD-PLATED CONTACTS

Gold-plated contacts should be used for longer rotational life, in corrosive environment or in case the switch will not be actuated for a long period of time.